

## Gas Instantaneous Water Heater

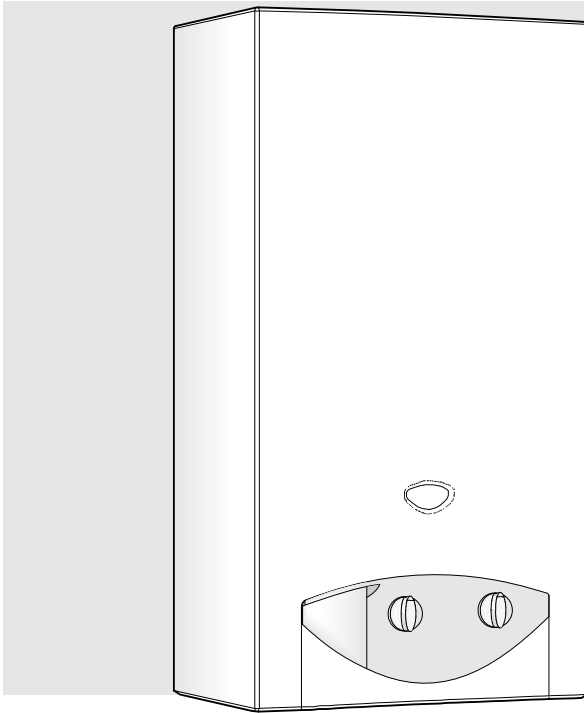

6720606492-00.1JS

**WR10..B...**  
**WR11..B...**

**With electronic ignition and triple safety system consisting of ionisation detector, flue gas monitor and heat exchanger temperature sensor.**

### **Safety instructions:**

If you smell gas:

- Do not operate any electrical switches.
- Do not telephone from inside the danger area.
- Turn off the gas cock.
- Open windows and ventilate room.
- From outside, call the gas company and your approved installer.

Do not use or store easily combustible materials in the vicinity of the appliance.

**Installation and servicing of the appliance may only be carried out by an approved technician.**

The appliance should be regularly serviced in order to ensure that it remains in perfect and safe working order.

If there is a risk of freezing, the appliance must be switched off and drained. If the appliance has not been drained during a cold spell, when it is switched on again check that it produces hot water. If problems occur, contact your installer

## Contents

<b>1. Technical Characteristics and Dimensions</b>	
1.1 Category, Appliance Type and Approval Number .....	2
1.2 General Description .....	2
1.3 Explanation of Model Code .....	2
1.4 Dimensions .....	3
1.5 Appliance design .....	3
1.6 Circuit diagram .....	4
1.7 Technical characteristics .....	4
<b>2. Preconditions for installation</b>	
2.1 Regulations .....	5
2.2 Location .....	5
2.3 Fixing the appliance .....	5
2.4 Water connection .....	5
2.5 Gas connection .....	5
2.6 Flue .....	5
2.7 Commissioning .....	6
<b>3. Operation and maintenance</b>	
3.1 Function .....	6
3.2 Water temperature control .....	6
3.3 Appliance adjustments .....	6
3.4 Maintenance .....	6
3.5 Purge the appliance .....	6
3.6 Flue gas safety device .....	6
3.7 Converting to a different gas type .....	7
3.8 Troubleshooting .....	7
<b>4. Operation</b> .....	<b>8</b>

## 1. Technical Characteristics and Dimensions

### 1.1 Category, Appliance Type and Approval Number



MODEL		CATEGORY
WR10	CH, ES, GB, IT, PT, HR	I <sub>2H</sub>
	BE, FR, LU	I <sub>2E+</sub>
WR11	BE, CH, ES, FR, GB, IT, PT, LU, HR	I <sub>3+</sub>
	NL, DE	I <sub>3B/P</sub>
TYPE	B <sub>11BS</sub>	

### 1.2 General Description

The appliance is easy to operate as it is ready to use at the press of a button.

Guaranteed safety provided by:

- Gas-tight ionisation detector that prevents escape of gas if there is no flame.
- Flue gas safety device that switches off the appliance if the flue is not functioning properly.
- Temperature limiter which protects the heat exchanger against overheating.

Electronic ignition controlled by opening of water valve.

Absence of a permanent pilot flame make it more economical than conventional appliances.

Semi-permanent pilot flame functions only during the time between opening of the water valve and activation of the main burner.

Heat exchanger has no tin/lead lining.

Automatic water valve made of glass-fibre reinforced polyamide, 100% recyclable.

Automatic control of water flow maintains constant flow rate even with fluctuating supply pressure.

Proportional adjustment of gas and water flow rates in order to ensure an even temperature gradient.

Green LED indicates burner condition.

### 1.3 Explanation of Model Code

W	R	10	B	23	S...
W	R	11	B	31	S...

- W Gas instantaneous water heater
- R Proportional output control
- 10 Flow rate (l/min)
- B Electronic ignition powered by 1.5 V batteries
- 23 Natural gas type H
- 31 LPG (butane/propane)
- S... Country code

## 1.4 Dimensions

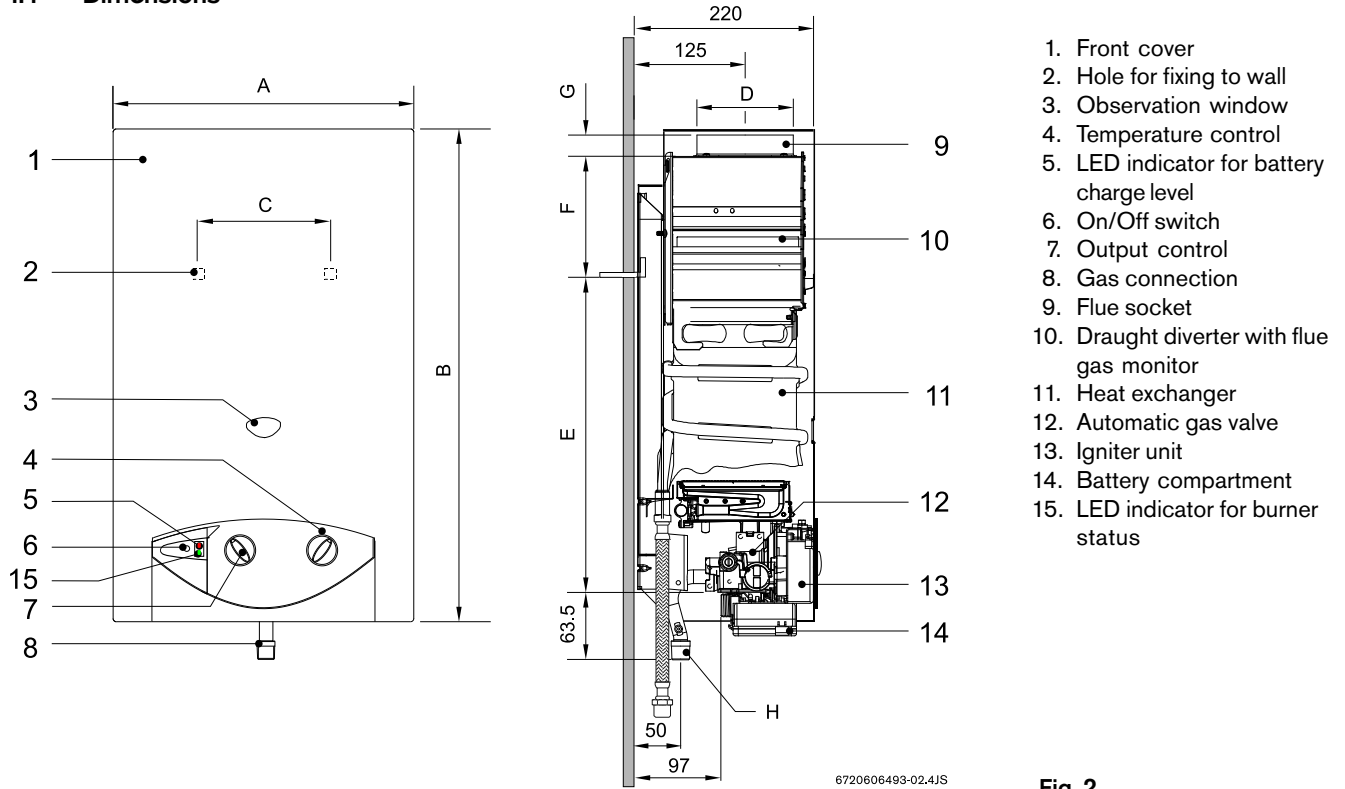

Fig. 2

Dimensions (mm)	A	B	C	D	E	F	G	H (Ø)	
								Natural Gas	LPG
WR10..B...	310	580	228	112,5	463	60	25	3/4"	1/2"
WR11..B...									

## 1.5 Appliance design

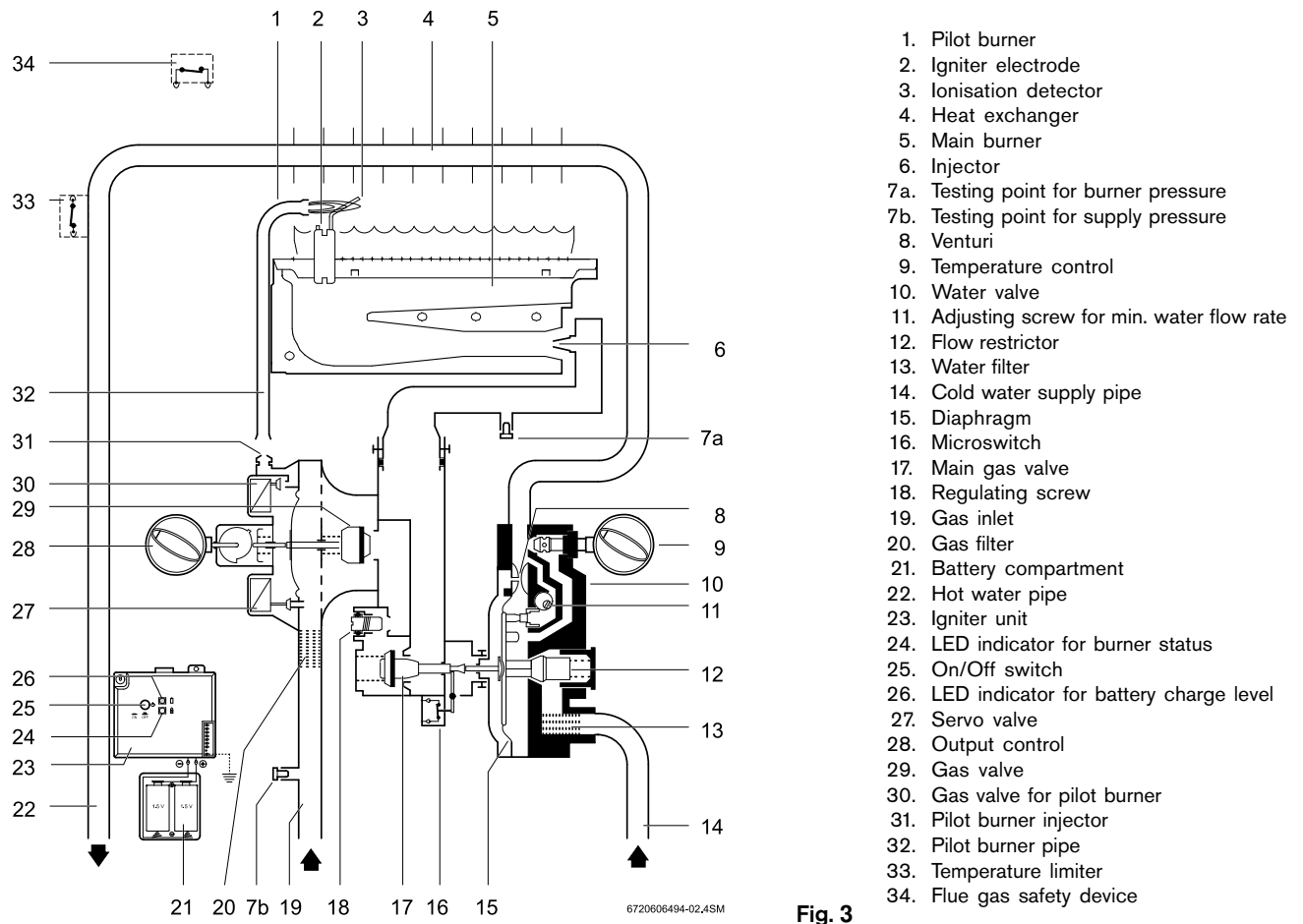

Fig. 3

## 1.6 Circuit diagram

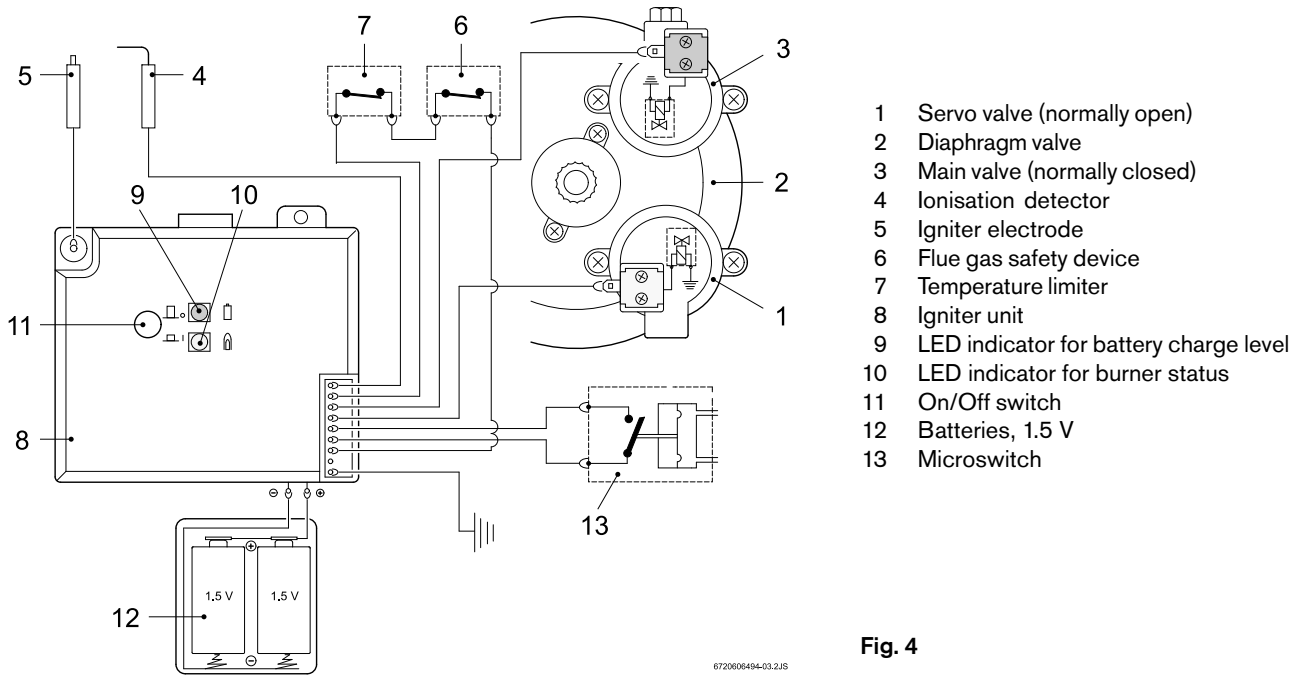

Fig. 4

## 1.7 Technical characteristics

	Technical Data	Symbol	Unit	WR10	WR11	
Output and heat demand	Rated max. heat output	$P_n$	kW	17.4	19.2	
	Rated min. heat output	$P_{min}$	kW	7.0	7.0	
	Output (modulation range)		kW	7.0 - 17.4	7.0 - 19.2	
	Rated max. heat input	$Q_n$	kW	20.0	21.8	
	Rated min. heat input	$Q_{min}$	kW	8.1	8.1	
Gas supply specifications *	<b>Supply pressure</b>					
	Natural gas	G20/25	mbar	20/25		
	LPG (butane/propane)	G30/G31	mbar		28-30/37	
	<b>Consumption</b>					
	Natural gas	G20/25	m <sup>3</sup> /h	2.3		
LPG (butane/propane)	G30/G31	kg/h		1.7		
	Number of injectors		12	12		
Water system specifications	<b>Max. water pressure**</b>		$p_w$	bar	12	12
	<b>Temperature control at maximum setting</b>					
	Temperature increase		°C	50	50	
	Flow rate		l/min	5.5	5.5	
	Min. operating pressure		$p_{wmin}$	bar	0.15	0.15
	<b>Temperature control at minimum setting</b>					
	Temperature increase		°C	25	25	
Flow rate		l/min	10	11		
Min. operating pressure		bar	0.2	0.2		
Flue specifications***	Draught requirement		mbar	0.015	0.015	
	Flow rate		g/s	13	13	
	Temperature		°C	170	170	

\*  $H_i$  15°C - 1013 mbar - dry : Natural gas 34.2 MJ/m<sup>3</sup> (9.5 kWh/m<sup>3</sup>)  
 LPG: Butane 45.7 MJ/kg (12.7 kWh/kg)

Propane 46.4 MJ/kg (12.9 kWh/kg)

\*\* This figure must not be exceeded taking account of water expansion

\*\*\* At maximum rated heat output

## 2. Preconditions for installation

The appliance can only be sold in the countries mentioned in the type plate.

### 2.1 Regulations

Gas safety (installation & use) Regulations 1998.

It is the law in GB that a competent Person in accordance with the above regulations installs all gas appliances.

Failure to install appliances correctly could lead to prosecution.

It is in your interest, and that of safety, to ensure compliance with the law.

#### Caravan & holiday homes:

the installation must meet the following standards Bs 5482:2 LPG and EN721 ventilation.

### 2.2 Location

The appliance should be sited in a well ventilated room where it will not be exposed to temperatures below freezing.

To prevent corrosion, the combustion air must not contain any corrosive substances. Substances classed as corrosion-promoting include halogenated hydrocarbons such as are found in solvents, paints, adhesives, aerosol propellants and various household cleaners. Appropriate measures should be taken where necessary.

With the exception of the flue pipe, the surface temperature of the appliance is below 85 °C. No special safety measures are therefore necessary.

Site appliance as shown in Fig. 6.

Always site appliance in a location not exposed to temperatures below freezing. If this is not possible, the appliance must be switched off and drained and the batteries removed whenever there is a risk of freezing.

Do not install the appliance in rooms where the free volume is less than 8 m<sup>3</sup>.

#### Air admission

The room where the appliance is to be installed should be provided of fresh air inlet areas according with the below table.

Appliance	Minimum area
WR 10	≥ 60 cm <sup>2</sup>
WR 11	

Minimum requirements are listed above. Local regulations should always be observed.

### 2.3 Fixing the appliance

Remove the temperature control and the output control.

Remove the outer case by sliding it forwards and then lifting upwards.

Fix the appliance using the sleeves and hooks supplied so that it is vertical.

**Never allow the appliance to rest against water or gas pipes.**

### 2.4 Water connection

It is advisable to drain the appliance before installing it as any dirt or grit inside it could reduce the water flow rate and,

in extreme cases, could completely clog up the appliance. Mark hot water (fig.5,pos.B) and cold water pipes (fig.5, pos.A) so as to prevent confusion.

Connect pipe to automatic water valve using the connecting kit supplied.

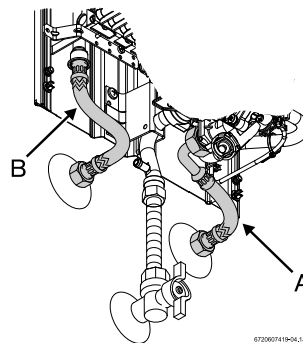

Fig. 5 Water connection

To prevent problems caused by sudden pressure fluctuations in the water supply, it is advisable to fit a non-return valve to the water outlet.

### 2.5 Gas connection

Take care to ensure dirt is not allowed to enter gas inlet.

Make sure that the type of gas specified on the appliance type plate is the same as that supplied by the gas authorities. Select pipe diameter to suit output of instantaneous water heater being installed.

Fit gas service cock as close to appliance as possible.

### 2.6 Flue

It is absolutely essential that all instantaneous water heaters are connected to a suitably dimensioned flue pipe by means of a gas-tight connection.

The flue pipe should be made of galvanised iron, aluminium, stainless steel or fibre concrete. Fit as shown in Fig. 6.

A flexible or rigid pipe should be used, fit it inside the flue socket. The external diameter of the pipe should be slightly smaller than the dimension specified in the appliances dimensions table.

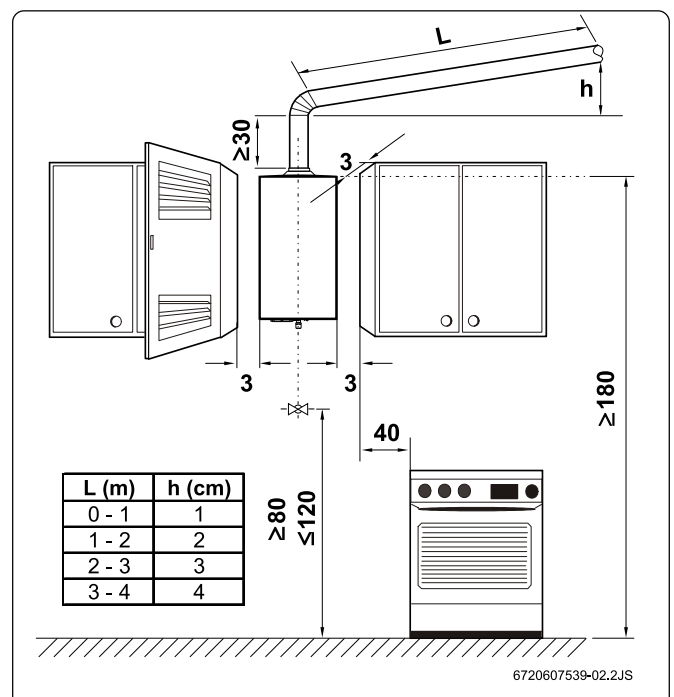

Fig. 6 Minimum distances (in cm)

## 2.7 Commissioning

Turn on the gas and water cocks and check all connections for leaks.

The two 1.5 V type R batteries supplied must be correctly fitted (Fig. 8).

Check flue gas safety device good functioning, proceed as explained in section 3.6.

## 3. Operation and maintenance

### Sealed parts must not be interfered with.

### 3.1 Function

This water heater is fitted with automatic electronic ignition that provides for easy commissioning.

All that is required is to press the On/Off switch (Fig. 8).

The appliance will then ignite automatically as soon as a hot water tap is turned on. The pilot flame ignites first and then, about four seconds later, the main burner; the pilot flame subsequently goes out after about 20 seconds.

Consequently, the appliance is substantially more economical because the pilot flame only remains lit until the main burner ignites, in contrast with conventional appliances on which the pilot flame remains alight constantly. After successful ignition, positioning it according to your output requirement. The further to the left you position the output control the higher the output, and consequently the higher the consumption of gas. Maximum output is obtained when the slide control is to the far left.

In order to optimise energy consumption, adjust slide control position to supply the minimum output required.

If there is air in the gas pipe when the appliance is commissioned, this can cause ignition failure. In such cases, the hot water tap should be turned off and then on again so that the appliance repeats the ignition cycle. The procedure should be repeated as necessary until the gas pipe is purged of air.

**Danger:** the area in front of the burner can reach very high temperatures, and there is a risk of burning on contact.

### 3.2 Water temperature control

The water temperature control is used to adjust the water flow rate, and thereby the water temperature, to the desired setting.

Turning the control clockwise reduces the water flow rate and increases the temperature; turning the control anti-clockwise increases the water flow rate and reduces the temperature.

If the temperature is set only as high as required, energy consumption is reduced and the likelihood of scale deposits in the heat exchanger minimised.

### 3.3 Appliance adjustments

All instantaneous water heaters are factory-adjusted and require no further adjustment.\*

Water heaters that use LPG (liquefied petroleum gas, i.e. butane/propane) are set to the operating pressure stated on the identification plate (28-30 mbar/37 mbar).

Natural gas appliances are set to a Wobbe Index of 15 kWh/m<sup>3</sup> and a supply pressure of 20/25 mbar.

\* **Sealed components must not be tampered with.**

## 3.4 Maintenance

The appliance should only be serviced by an approved engineer.

A complete overhaul should be carried out after two years. The overhaul should involve thoroughly cleaning the heat exchanger, burner, pilot burner and automatic water valve filter.

If necessary, the inside of the heat exchanger and the connecting pipes should be descaled.

Check the gas and water valves for leaks and carry out a complete function check.

If components need to be replaced, **use only genuine Bosch spare parts.**

### 3.5 Purge the appliance

If there is a risk of freezing, proceed as follows:

Remove the retaining clip from threaded bushing (pos.1).

Remove threaded bushing (pos. 2) from water valve.

Empty the appliance of all water.

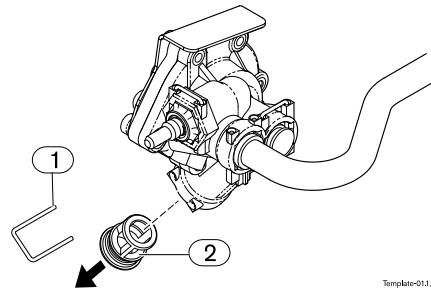

Fig. 7 Purge the appliance

### 3.6 Flue gas safety device

The recommissioning must be done from a qualified technician only.

The flue gas safety device must not under any circumstances be switched off, simulated or replaced by any other component.

### Operation and safety precautions

The flue gas safety device checks the effectiveness of flue gas extraction by the flue. If it is inadequate, the appliance switches off automatically so that the combustion fumes do not escape into the room in which the appliance has been installed. The flue gas safety device resets after a cooling-down period.

If the appliance shuts down while in operation, ventilate the room. Wait about 10 minutes then restart the appliance. If the problem recurs, call an engineer. The user must never make any modifications to the appliance.

### Maintenance

If faults occur on the flue gas safety device, proceed as follows:

- Undo flue gas safety device fixing screw.
- Unplug igniter unit connector
- Unplug battery connector

Replace damaged component with new one and refit using the reverse of the procedure set out in the text above.

### Function check\*

Flue gas safety device function check:

- Disconnect flue pipe
- Replace with pipe (about 50 cm long) with sealed end
- Fit pipe vertically
- Start up appliance at rated output and set temperature control to maximum temperature.

Under those conditions, the appliance should shut down after two minutes. Remove temporary pipe and reconnect flue pipe.

\* This work may only be carried out by an approved engineer.

### 3.7 Converting to a different gas type

Use only the **genuine Bosch conversion kit**. Conversion may only be carried out by an approved technician.

### 3.8 Troubleshooting

Installation, servicing and repairs may only be carried out by an approved engineer.

The following table illustrates only a few solutions to straightforward problems.

Fault	Possible Cause	Solution
Appliance does not ignite.	Batteries flat, incorrectly fitted or switch set to Off	Check position and refit/replace.
Pilot flame lights slowly/with difficulty	Batteries flat.	Replace.
Red LED flashes		
Water not hot enough		Check position of water temperature control and adjust to obtain desired hot water temperature
Water not hot enough, no flame	Gas supply dynamic pressure too low	Check gas cylinder governor and replace if incompatible or damaged Check whether gas cylinder (butane) is freezing when appliance is in operation and re-site in warmer location if necessary
Flame goes out while appliance is in operation	Temperature limiter has tripped Flue gas safety device has tripped	Wait 10 minutes then restart appliance. If problem recurs, call an approved technician. Ventilate room. Wait 10 minutes then restart appliance. If problem recurs, call an approved technician.
Reduced water flow rate	Inadequate inlet flow rate Dirt in water service cock or mixer unit Automatic water valve clogged Heat exchanger clogged (scale)	Check and adjust. Check and clean. Clean filter.* Clean and descale as necessary.*

The operations marked with “\*” may only be carried out by an approved technician

## 4. Operation

### Turn on all gas and water taps Purge air from pipes

Insert two 1.5 V type R 20 batteries  
in battery compartment

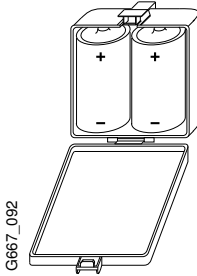

G667\_092

#### Safety precautions for use of batteries:

- Do not dispose of batteries with normal household waste, take them to a recycling site instead.
- Do not re-use worn out batteries.
- Use only batteries of the specified type

If the red LED starts flashing,  
replace batteries

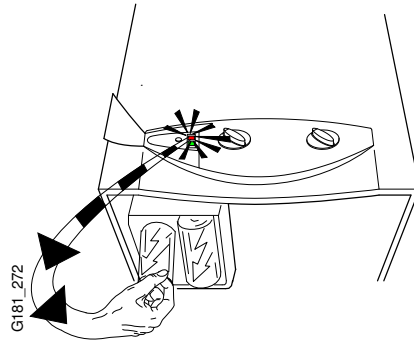

G181\_272

### Switching on/off

Press "⏻" switch to switch  
appliance on/off

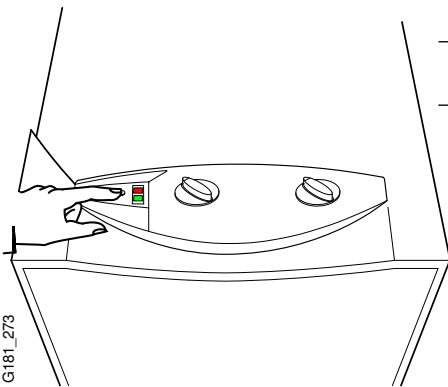

G181\_273

- - On (I)
- - Off (0)

Green LED off = Main burner off  
Green LED on = Main burner on

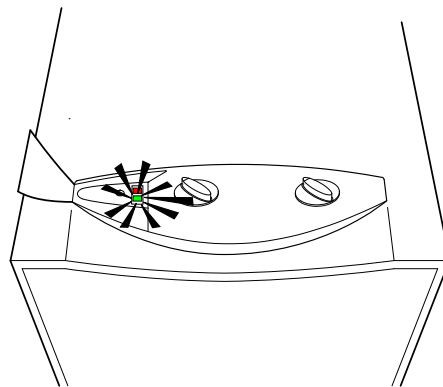

### Output control

Low water temperature  
Lower output

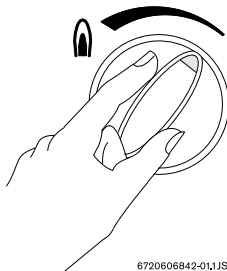

6720606842-01.1JS

High water temperature  
Higher output

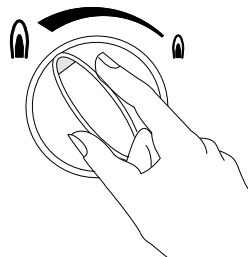

6720606842-02.1JS

### Temperature adjustment

Turning control anti-clockwise  
increases water flow rate and  
reduces water temperature

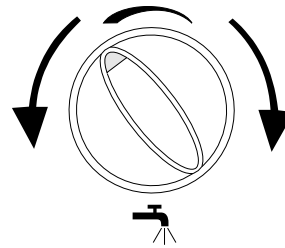

6720606494-06.1JS

Turning control clockwise

reduces water flow rate and  
increases water temperature

Fig. 8